

**Transient Voltage Suppressor**

Version: A1 2015-11-25

**Features**

- IEC 61000-4-2(ESD)±15KV(air), ±8KV(contact)
- 150Watts peak pulse power (tp=8/20μS)
- Ultra low capacitance: 1.5pF maximum
- Low clamping voltage
- Moisture sensitivity level: Level 1
- Weight 5.0 mg
- Small package: SOD-323

**Exterior**

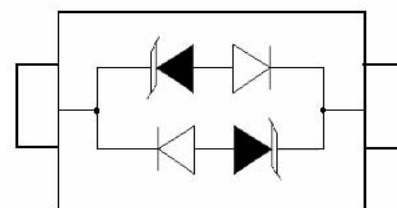

SOD-323

**Application Information**

- xDSL secondary
- Ethernet

**Agency Approvals**

Icon	Description
<b>RoHS</b>	Compliance with 2011/65/EU
<b>HF</b>	Compliance with IEC61249-2-21:2003
	Mean lead free

**Part Number and Electrical Parameter**

Part Number	$I_{DRM}@V_{DRM}$		$V_{BR}^{①}@I_R$		$V_C@I_{pp}^{②}$		$V_C@I_{pp}^{②}$		$C_o^{③}$
	μA	V	V	mA	V	A	V	A	pF
	MAX		MIN		MAX		MAX		MAX
BV03C	20	3	4	1	5.15	1	13.9	8	1.5

Absolute maximum ratings measured at T= 25°C RH = 45%-75% (unless otherwise noted).

①  $V_{BR}$  is measured at  $I_R=1mA$

② Surge Waveform: 8/20 μ S.

③ Off-state capacitance is measured in  $V_{DC}=0V, V_{RMS}=1V, f=1MHz$

**Part Numbering System**

BV 03 C  
(1) (2) (3)

- (1) Bencent Transient Voltage Suppressor
- (2) Stand-state Voltage, e.g. 03=3V
- (3) Bidirectional polar

**Mark**



CC: Part Number

V-I Curve

Parameters	Definition
$V_C$	Clamping Voltage
$I_{PP}$	Surge Waveform 8/20 $\mu$ s
$V_{DRM}$	Stand-off Voltage
$V_{BR}$	Breakdown Voltage
$I_{DRM}$	Reverse Leakage Current
$I_R$	Test Current
$P_{pp}$	Peak Pulse Power Dissipation

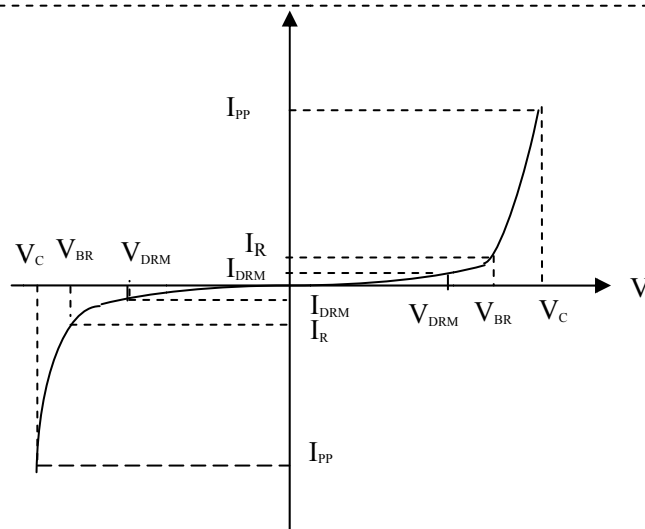

Thermal Considerations

symbol	Parameter	Value	Unit
$T_j$	Operating Junction Temperature Range	-55 to +150	$^{\circ}$ C
$T_s$	Storage Temperature Range	-55 to +150	$^{\circ}$ C

Environmental Characteristics

Testing items	Technical standards
High Temperature Reverse Bias Test	Temperature: $150 \pm 3^{\circ}$ C Bias= $80\%V_{DRM}$ Time:168H
High Temperature Life Test	Temperature: $150^{\circ}$ C Time:168H
High-low Temperature Cycle Test	Temperature: From $-40^{\circ}$ C to $125^{\circ}$ C Dwell time : 30min,10cycles
High Temperature &High Humidity Test	Temperature: $85^{\circ}$ C Humidity:85% Time:168H
Pressure Cooker Test	Temperature: $121^{\circ}$ C , 2atm. Humidity:100% Time:24H
Resistance of Soldering Heat	Temperature: $260 \pm 5^{\circ}$ C Time of dip soldering: 10s, 3times

Note: The above testing items can be specified by customer's special request

Transient Voltage Suppressor

Version: A1 2015-11-25

Product Dimensions

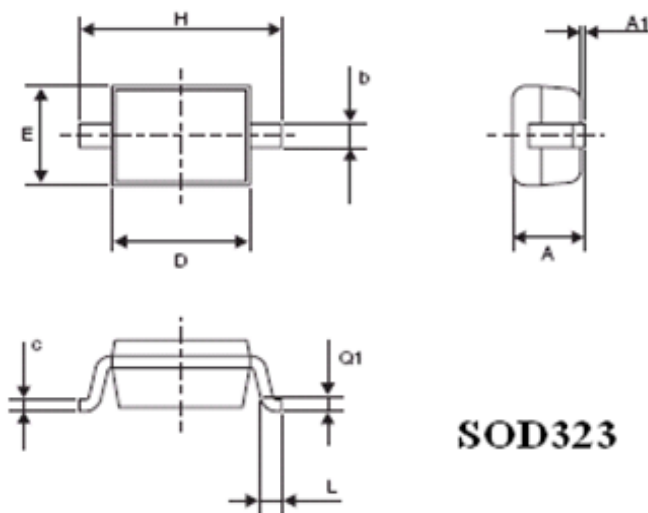

**SOD323**

REF	mm	inch
A	1.17	0.046
A1	0.1	0.004
b	0.34±0.10	0.013±0.0039
c	0.17±0.08	0.007±0.0032
D	1.66±0.14	0.065±0.0055
E	1.28±0.17	0.050±0.0066
H	2.5±0.2	0.098±0.0079
L	0.28±0.18	0.011±0.0071
Q1	0.25±0.15	0.010±0.0059

Recommended Soldering Pad

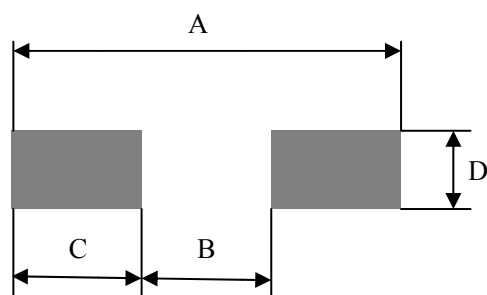

REF	mm	inch
A	3.20	0.126
B	1.08	0.043
C	1.06	0.042
D	0.54	0.021

Reflow Profile

Reflow Condition		Pb-Free assembly
Pre Heat	Temperature Min	150°C
	Temperature Max	200°C
	Time (min to max)	60 – 180 secs
Average ramp up rate (Liquidus) T <sub>L</sub> to peak		3°C/s max
T <sub>S(max)</sub> to T <sub>L</sub> - Ramp-up Rate		3°C/s max
Reflow	- Temperature (T <sub>L</sub> ) (Liquidus)	217°C
	- Temperature (T <sub>L</sub> )	60 – 150 secs
Peak Temperature (T <sub>P</sub> )		260+0/-5 °C
Time within 5°C of actual peak Temperature (T <sub>P</sub> )		30secs
Ramp-down Rate		6°C/s max
Time 25°C to peak Temperature (T <sub>P</sub> )		8 min max.
Do not exceed		260°C

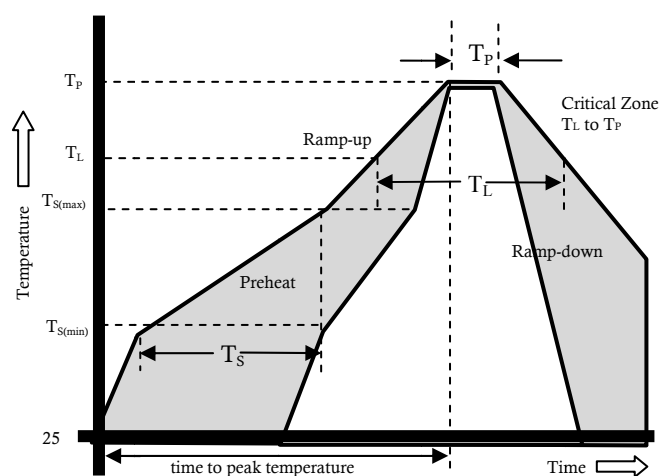

Transient Voltage Suppressor

Version: A1 2015-11-25

Package Reel Information

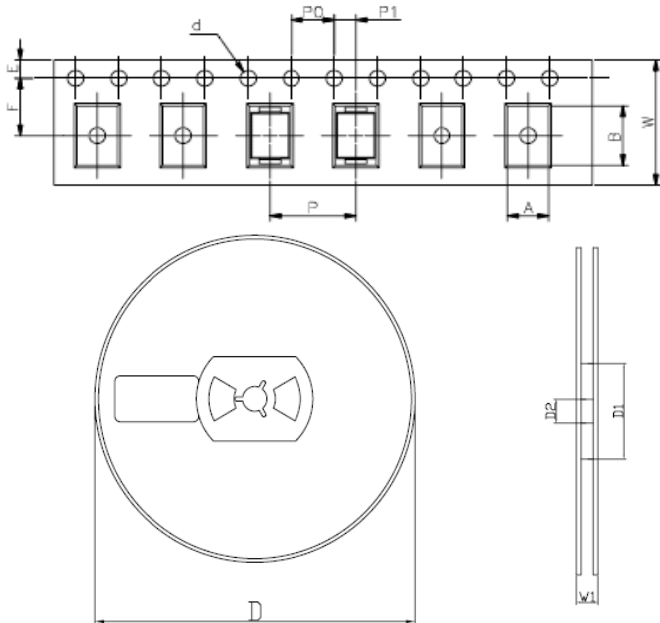

REF	mm	inch
A	1.46+/-0.1	0.057+/-0.004
B	3.3+/-0.1	0.114+/-0.004
d	1.25+/-0.1	0.049+/-0.004
D	178+/-1.0	7.01+/-0.039
D1	55+/-3	2.165+/-0.118
D2	13+/-0.5	0.512+/-0.020
E	1.75+/-0.1	0.069+/-0.004
F	3.5+/-0.2	0.138+/-0.008
P	4.0+/-0.2	0.158+/-0.008
P0	4.0+/-0.2	0.158+/-0.008
P1	2.0+/-0.2	0.079+/-0.008
W	8.0+/-0.2	0.315+/-0.008
W1	14.4+/-0.5	0.567+/-0.020

OUTLINE	REEL (PCS)	PER CARTON (PCS)	REEL DIAMETERS (mm)	CARTON SIZE(mm)		
				L	W	H
TAPING	3,000	90,000	177	390	370	220